

**EMERGENZA  
COVID19**

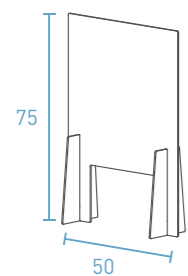

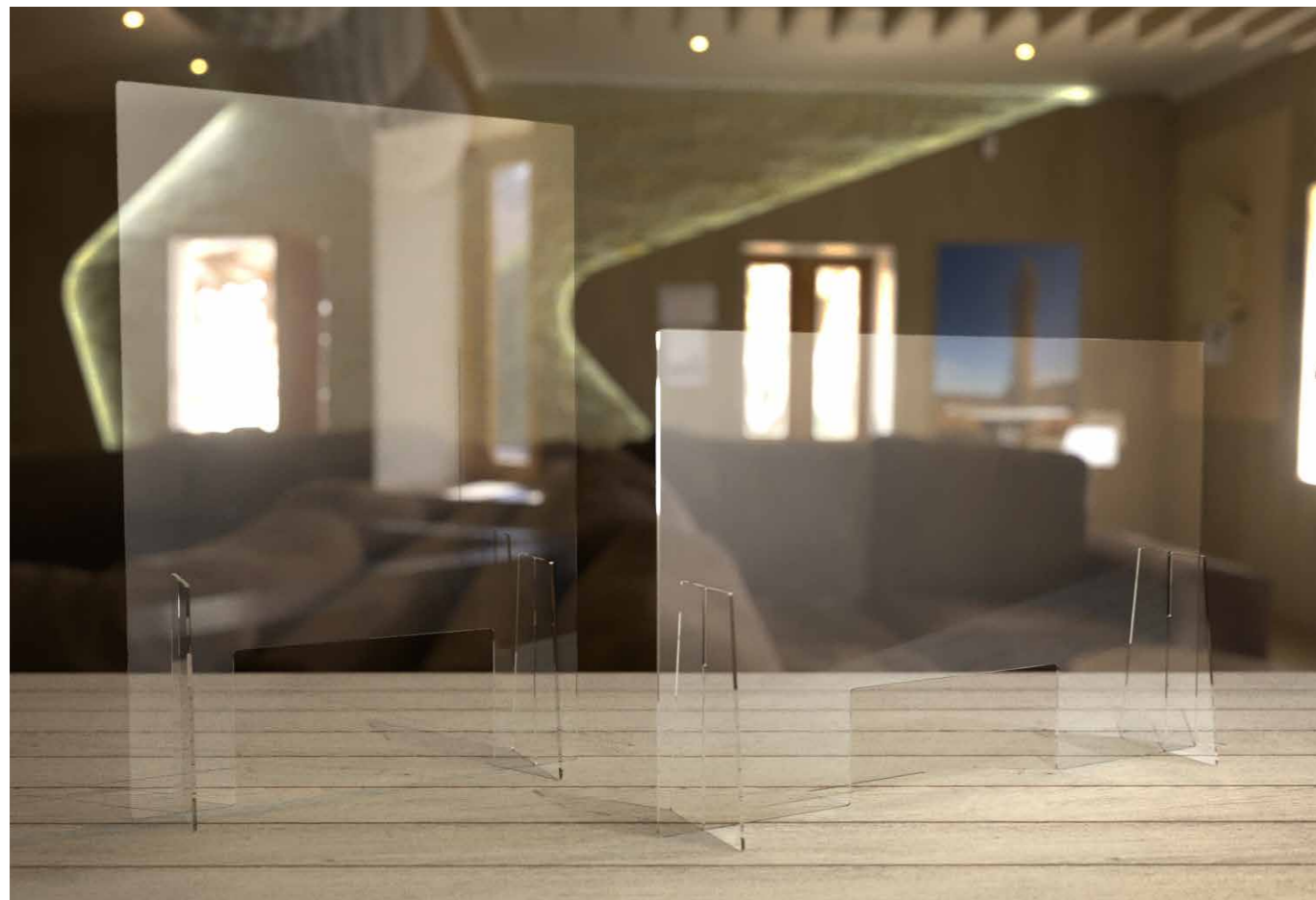

**PF100**

Parafiato: 50 x h.75 x 18 cm  
 Foro: 30 x h.20 cm

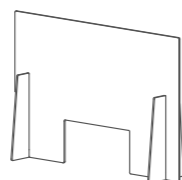

**PF200**

Parafiato: 75 x h.50 x 18 cm  
 Foro: 30 x h.15 cm

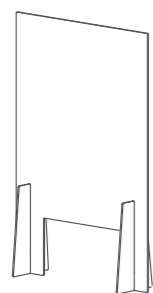

**PF101**

Parafiato: 60 x h.90 x 18 cm  
 Foro: 35 x h.20 cm

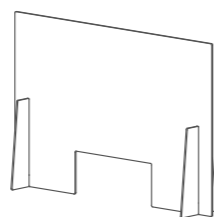

**PF201**

Parafiato: 90 x h.60 x 18 cm  
 Foro: 35 x h.15 cm

**XSPECIAL01**  
 Kit "Appoggio"

- Adatto a barriere fino a 10 mm di spessore
- Per ripiani fino a 30 mm di spessore (oltre su richiesta)
- Apertura finestra h.60 mm
- Rondelle in plex bianco (o trasparente) con viti fornite
- Non adatto a barriere o ripiani in vetro
- Kit da due supporti; barriera non inclusa

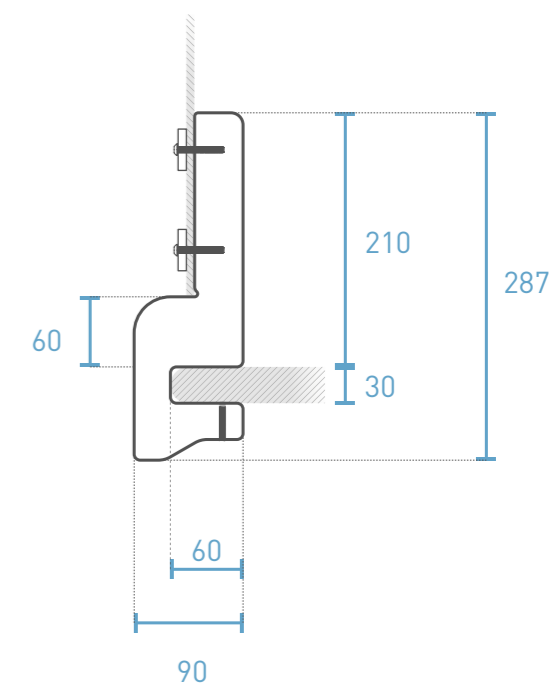

- Misure in millimetri



## XSPECIAL02

### Kit "Libero"

- Adatto a barriere fino a 10 mm di spessore
- Per ripiani fino a 30 mm di spessore (oltre su richiesta)
- Nessuna finestra
- Rondelle in plex bianco (o trasparente) con viti fornite
- Non adatto a barriere o ripiani in vetro
- Kit da due supporti; barriera non inclusa

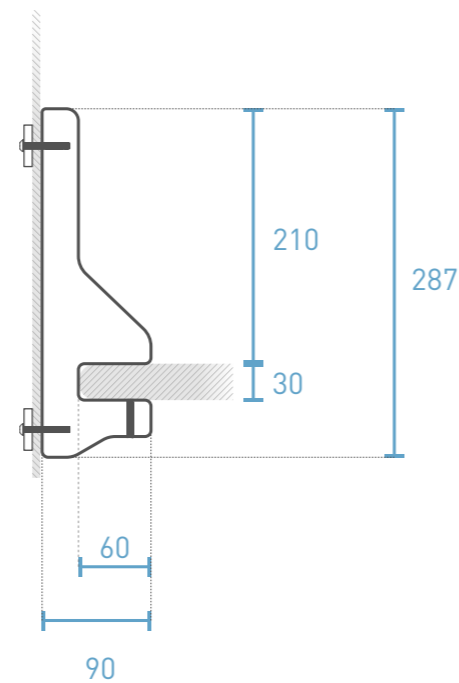

- Misure in millimetri



## XSPECIAL03

### Kit "Incastro"

- Adatto a barriere fino a 5 mm di spessore
- Per ripiani fino a 30 mm di spessore (oltre su richiesta)
- Apertura finestra h.60 mm
- Non adatto a barriere o ripiani in vetro
- Kit da due supporti; barriera non inclusa

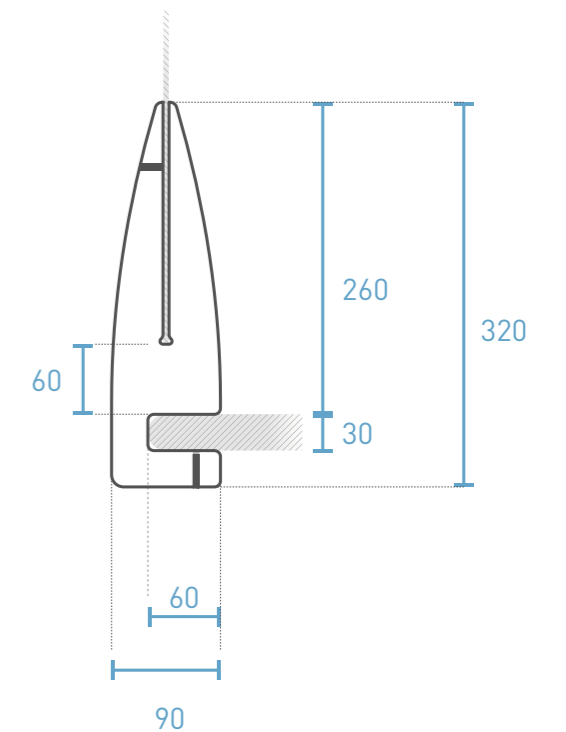

- Misure in millimetri

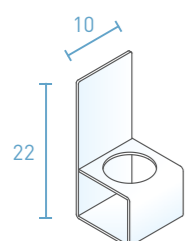

**DPT001**

**Dispenser in plexiglass trasparente**

Dispenser: 10 x h.22 cm  
Foro: Ø 7 cm

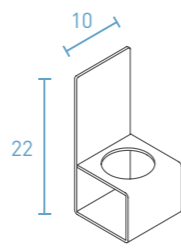

**DPB001**

**Dispenser in plexiglass bianco**

Dispenser: 10 x h.22 cm  
Foro: Ø 7 cm

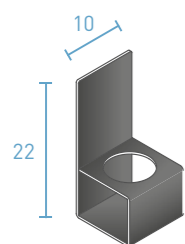

**DPN001**

**Dispenser in plexiglass nero**

Dispenser: 10 x h.22 cm  
Foro: Ø 7 cm

**Personalizzazione inclusa:**

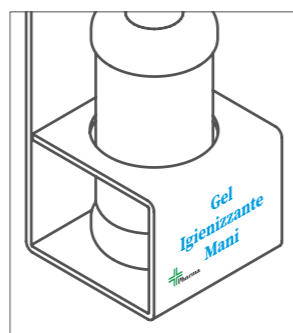

**Stampa nel fronte**  
Esempio:

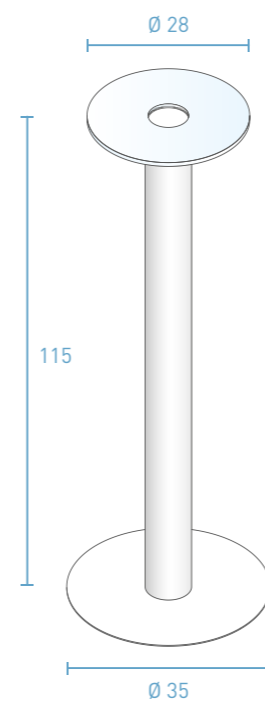

**CPF001**

**Dispenser da terra in ferro verniciato con top in plexiglass**

Dispenser: h.115 x 35 x 35 cm  
Tubo: Ø 7,7 cm

NOTE: possibilità di scegliere la base ed il top con forma quadrata

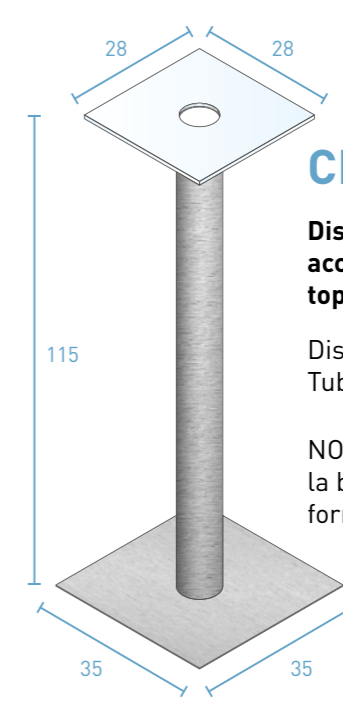

**CPX001**

**Dispenser da terra in acciaio con top in plexiglass**

Dispenser: h.115 x 35 x 35 cm  
Tubo: Ø 7,7 cm

NOTE: possibilità di scegliere la base ed il top con forma rotonda





### WSPECIAL01

#### Tetto

- Misure: 74 x h.15 x 16 cm
- Pieghevole per il trasporto
- Distanza piano-barriera: 10 cm

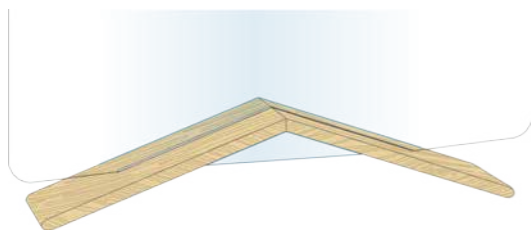

### WSPECIAL02

#### Triangolo

- Misure: 21 x h.10.5 x 15 cm
- Distanza piano-barriera: 6 cm
- Si consiglia 2 supporti per barriere superiori a 70cm

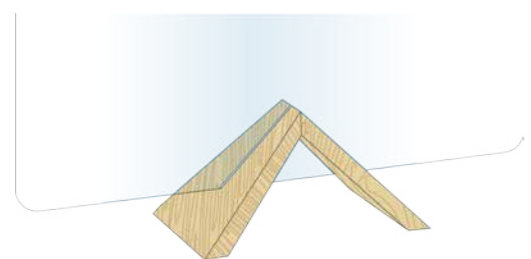

### WSPECIAL03

#### Piramide

- Misure: 22 x h.11 x 16 cm
- Distanza piano-barriera: 6 cm
- Si consiglia 2 supporti per barriere superiori a 70cm

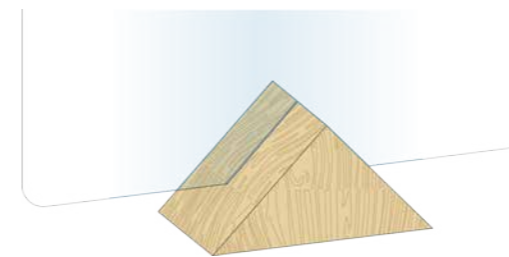

### WSPECIAL04

#### Contentitore

- Misure: 25 x h.11,5 x 15 cm
- Da riempire a piacere per zavorra
- Distanza piano-barriera: 11,5 cm

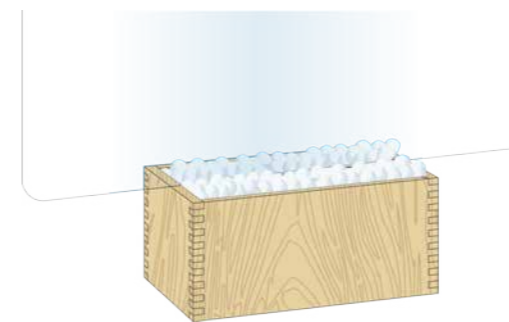

### WSPECIAL05

#### Angolo

- Misure: 20 x h.16 x 20 cm (singolo)
- Smontabile per trasporto
- Distanza piano-barriera: 1 cm

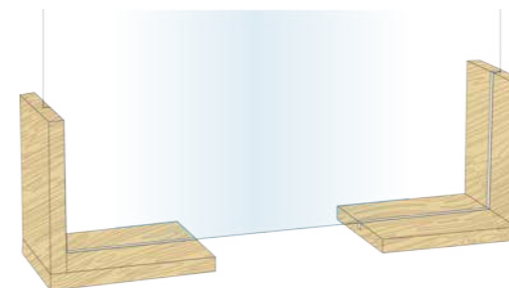

### WSPECIAL06

#### Blocchi

- Misure: 8 x h.8 x 20 cm (singolo)
- Distanza piano-barriera: a filo



### WSPECIAL07

#### Portamenù

- Legno: 60 x h.22 x 15 cm
- Distanza piano-barriera: a filo

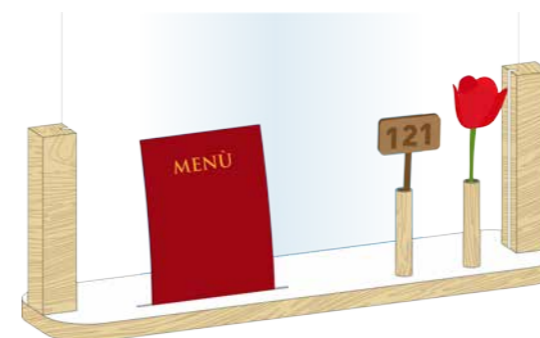



### CPL001

**Colonna per dispenser  
con accessori in abete**

Colonna: h.155 x 35 x 35 cm

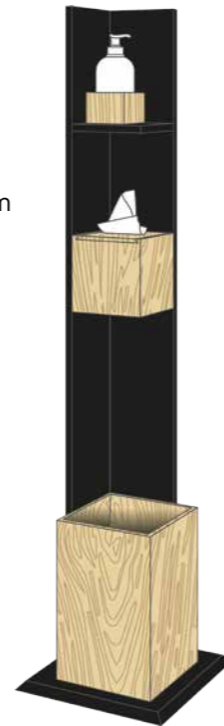

**LASER STYLE ITALIA srl**

Treviso

---

Servizio di marcatura,  
incisione e taglio laser  
conto terzi

Idee e soluzioni  
per premiare, promuovere  
ed esporre

---

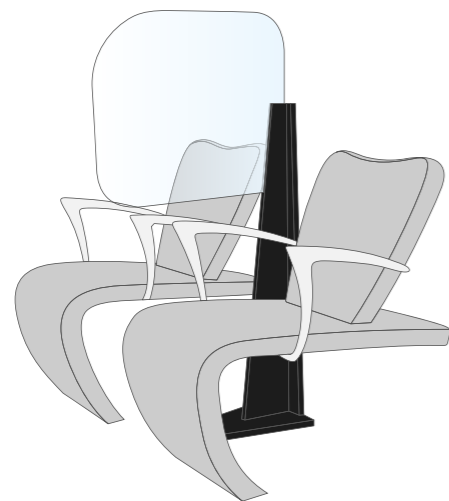

### BPP001

**Divisorio lavacapelli  
per parrucchieri**

Divisorio: h.tot. 120 cm  
Struttura: h.95 x 35 x 25 cm  
Barriera: h.60 x 50 cm



